

DAIKIN

INSTALLATION MANUAL

SPLIT SYSTEM Air Conditioners

MODELS

RZQ18PVJU (9)

RZQ24PVJU (9)

RZQ30PVJU

RZR18PVJU

RZR24PVJU

RZR30PVJU

English

Français

Español

Read these instructions carefully before installation.
Keep this manual in a handy place for future reference.
This manual should be left with the equipment owner.

Lire soigneusement ces instructions avant l'installation.
Conserver ce manuel à portée de main pour référence ultérieure.
Ce manuel doit être donné au propriétaire de l'équipement.

Lea cuidadosamente estas instrucciones antes de instalar.
Guarde este manual en un lugar a mano para leer en caso de tener alguna duda.
Este manual debe permanecer con el propietario del equipo.

CONTENTS

1. SAFETY CONSIDERATIONS	1
2. INTRODUCTION	3
3. BEFORE INSTALLATION.....	4
4. SELECTION OF INSTALLATION LOCATION	4
5. CAUTIONS ON INSTALLATION.....	8
6. REFRIGERANT PIPING WORK	9
7. ELECTRIC WIRING WORK	12
8. CHECKS AFTER COMPLETION OF WORK.....	15
9. TEST RUN PROCEDURE.....	15
10. CAUTION FOR REFRIGERANT LEAKS	17

1. SAFETY CONSIDERATIONS





Read these “SAFETY CONSIDERATIONS for Installation” carefully before installing air conditioning equipment. After completing the installation, make sure that the unit operates properly during the startup operation.

Instruct the customer on how to operate and maintain the unit. Inform customers that they should store this Installation Manual with the Operation Manual for future reference.

Always use a licensed installer or contractor to install this product. Improper installation can result in water or refrigerant leakage, electrical shock, fire, or explosion.

Meanings of **DANGER**, **WARNING**, **CAUTION**, and **NOTE**

Symbols:

-  **DANGER**..... Indicates an imminently hazardous situation which, if not avoided, will result in death or serious injury.
-  **WARNING**..... Indicates a potentially hazardous situation which, if not avoided, could result in death or serious injury.
-  **CAUTION**..... Indicates a potentially hazardous situation which, if not avoided, may result in minor or moderate injury. It may also be used to alert against unsafe practices.
-  **NOTE**..... Indicates situations that may result in equipment or property-damage accidents only.

DANGER

- Refrigerant gas is heavier than air and replaces oxygen. A massive leak can lead to oxygen depletion, especially in basements, and an asphyxiation hazard could occur leading to serious injury or death.
- Do not ground units to water pipes, gas pipes, telephone wires, or lightning rods as incomplete grounding can cause a severe shock hazard resulting in severe injury or death. Additionally, grounding to gas pipes could cause a gas leak and potential explosion causing severe injury or death.
- If refrigerant gas leaks during installation, ventilate the area immediately. Refrigerant gas may produce toxic gas if it comes in contact with fire. Exposure to this gas could cause severe injury or death.
- After completing the installation work, check that the refrigerant gas does not leak throughout the system.
- Do not install unit in an area where flammable materials are present due to risk of explosions that can cause serious injury or death.
- Safely dispose all packing and transportation materials in accordance with federal/state/local laws or ordinances. Packing materials such as nails and other metal or wood parts, including plastic packing materials used for transportation may cause injuries or death by suffocation.

WARNING

- Only qualified personnel must carry out the installation work. Installation must be done in accordance with this installation manual. Improper installation may result in water leakage, electric shock, or fire.
- When installing the unit in a small room, take measures to keep the refrigerant concentration from exceeding allowable safety limits. Excessive refrigerant leaks, in the event of an accident in a closed ambient space, can lead to oxygen deficiency.
- Use only specified accessories and parts for installation work. Failure to use specified parts may result in water leakage, electric shocks, fire, or the unit falling.
- Install the air conditioner on a foundation strong enough that it can withstand the weight of the unit. A foundation of insufficient strength may result in the unit falling and causing injuries.
- Take into account strong winds, typhoons, or earthquakes when installing. Improper installation may result in the unit falling and causing accidents.
- Make sure that a separate power supply circuit is provided for this unit and that all electrical work is carried out by qualified personnel according to local, state, and national regulations. An insufficient power supply capacity or improper electrical construction may lead to electric shocks or fire.
- Make sure that all wiring is secured, that specified wires are used, and that no external forces act on the terminal connections or wires. Improper connections or installation may result in fire.

- When wiring, position the wires so that the control box cover can be securely fastened. Improper positioning of the control box cover may result in electric shocks, fire, or the terminals overheating.
- Before touching electrical parts, turn off the unit.
- Be sure to install a ground fault circuit interrupter if one is not already available. This helps prevent electrical shocks or fire.
- Securely fasten the outdoor unit terminal cover (panel). If the terminal cover/panel is not installed properly, dust or water may enter the outdoor unit causing fire or electric shock.
- When installing or relocating the system, keep the refrigerant circuit free from substances other than the specified refrigerant (R410A) such as air. Any presence of air or other foreign substance in the refrigerant circuit can cause an abnormal pressure rise or rupture, resulting in injury.
- Do not change the setting of the protection devices. If the pressure switch, thermal switch, or other protection device is shorted and operated forcibly, or parts other than those specified by Daikin are used, fire or explosion may occur.

⚠ CAUTION

- Do not touch the switch with wet fingers. Touching a switch with wet fingers can cause electric shock.
- Do not allow children to play on or around the unit to prevent injury.
- Do not touch the refrigerant pipes during and immediately after operation as the refrigerant pipes may be hot or cold, depending on the condition of the refrigerant flowing through the refrigerant piping, compressor, and other refrigerant cycle parts. Your hands may suffer burns or frostbite if you touch the refrigerant pipes. To avoid injury, give the pipes time to return to normal temperature or, if you must touch them, be sure to wear proper gloves.
- Heat exchanger fins are sharp enough to cut. To avoid injury wear glove or cover the fins when working around them.
- Install drain piping to proper drainage. Improper drain piping may result in water leakage and property damage.
- Insulate piping to prevent condensation.
- Be careful when transporting the product.
- Do not turn off the power immediately after stopping operation. Always wait for at least 5 minutes before turning off the power. Otherwise, water leakage may occur.
- Do not use a charging cylinder. Using a charging cylinder may cause the refrigerant to deteriorate.
- Refrigerant R410A in the system must be kept clean, dry, and tight.
 - (a) Clean and Dry -- Foreign materials (including mineral oils such as SUNISO oil or moisture) should be prevented from getting into the system.

(b) Tight -- R410A does not contain any chlorine, does not destroy the ozone layer, and does not reduce the earth's protection against harmful ultraviolet radiation. R410A can contribute to the greenhouse effect if it is released. Therefore take proper measures to check for the tightness of the refrigerant piping installation. Read the chapter Refrigerant Piping Work and follow the procedures.

- Since R410A is a blend, the required additional refrigerant must be charged in its liquid state. If the refrigerant is charged in a state of gas, its composition can change and the system will not work properly.
- The indoor unit is for R410A. See the catalog for indoor models that can be connected. Normal operation is not possible when connected to other units.
- Remote controller (wireless kit) transmitting distance can be shorter than expected in rooms with electronic fluorescent lamps (inverter or rapid start types). Install the indoor unit far away from fluorescent lamps as much as possible.
- Indoor units are for indoor installation only. Outdoor units can be installed either outdoors or indoors.
- Do not install the air conditioner in the following locations:
 - (a) Where a mineral oil mist or oil spray or vapor is produced, for example, in a kitchen. Plastic parts may deteriorate and fall off or result in water leakage.
 - (b) Where corrosive gas, such as sulfurous acid gas, is produced. Corroding copper pipes or soldered parts may result in refrigerant leakage.
 - (c) Near machinery emitting electromagnetic waves. Electromagnetic waves may disturb the operation of the control system and cause the unit to malfunction.
 - (d) Where flammable gas may leak, where there is carbon fiber, or ignitable dust suspension in the air, or where volatile flammables such as thinner or gasoline are handled. Operating the unit in such conditions can cause a fire.
- Take adequate measures to prevent the outdoor unit from being used as a shelter by small animals. Small animals making contact with electrical parts can cause malfunctions, smoke, or fire. Instruct the customer to keep the area around the unit clean.

⚠ NOTE

- Install the power supply and control wires for the indoor and outdoor units at least 3.5 feet away from televisions or radios to prevent image interference or noise. Depending on the radio waves, a distance of 3.5 feet may not be sufficient to eliminate the noise.
- Dismantling the unit, treatment of the refrigerant, oil and additional parts must be done in accordance with the relevant local, state, and national regulations.
- Do not use the following tools that are used with conventional refrigerants: gauge manifold, charge hose, gas leak detector, reverse flow check valve, refrigerant charge base, vacuum gauge, or refrigerant recovery equipment.
- If the conventional refrigerant and refrigeration oil are mixed in R410A, the refrigerant may deteriorate.

- This air conditioner is an appliance that should not be accessible to the general public.
- The wall thickness of field-installed pipes should be selected in accordance with the relevant local, state, and national regulations.

〈Safety Precaution〉

The PCI Data Station is a class A product. In a domestic environment this product may cause radio interference in which case the user may be required to take adequate measures.

2. INTRODUCTION

2-1 Standard operation limit

The figures below assume following operating conditions for indoor and outdoor units:

Equivalent pipe length.....25 ft.

Level difference.....0 ft.

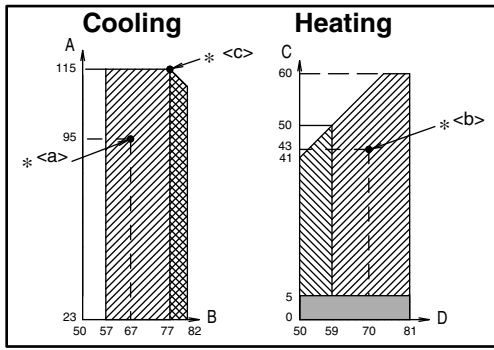

- A Outdoor temperature (°FDB)
- B Indoor temperature (°FWB)
- C Outdoor temperature (°FWB)
- D Indoor temperature (°FDB)
- Range for continuous operation
- Range for pull down operation
- Range for warming up operation
- Range for operation

2-2 Technical specifications

(*<a> and * in the table indicate the operating condition (shown in the left figure).)

Model	RZQ18PVJU RZR18PVJU	RZQ24PVJU RZR24PVJU	RZQ30PVJU RZR30PVJU	Precaution
Refrigerant	R410A			
Power	208/230V 60Hz			
[FAQ] Wall mounted				
Cooling (MBh)	18.0	24.0	—	*<a>
Heating (MBh) (RZQ only)	20.0	26.0	—	*
[FCQ] Ceiling mounted				
Cooling (MBh)	18.0	24.0	30.0	*<a>
Heating (MBh) (RZQ only)	20.0	27.0	34.0	*
[FHQ] Ceiling Suspended				
Cooling (MBh)	18.0	24.0	30.0	*<a>
Heating (MBh) (RZQ only)	20.0	27.0	34.0	*
(RZQ only)				
[FTQ] Air Handling Unit				
Cooling (MBh)	18.0	24.0	—	*<a>
Heating (MBh)	20.0	26.0	—	*
Dimensions H x W x D (inch)	30-5/16 x 35 7/16 x 12 5/8			
Weight (lb.)	150			
Connections				
Gas (inch)	5/8			
Liquid (inch)	3/8			

2-3 Electrical specifications

(*<c> in the table indicate the operating condition (shown in the left figure).)

Model	RZQ18PVJU RZR18PVJU	RZQ24PVJU RZR24PVJU	RZQ30PVJU RZR30PVJU	Precaution
Power				
Phase	~			
Frequency (Hz)	60			
Voltage (V)	208/230			
Voltage tolerance (%)	±10			
Max. Overcurrent Protective device (A)	20			
Min. Circuit Amps. (A)	16.5			*<c>
Compressor				
Phase	3~			
Frequency (Hz)	60			
Voltage (V)	208/230			

2-4 Accessories

Confirm that the following accessories are supplied.

Clamp	Insulation tube				Cover (Handle)
	(Large-1)	(Large-2)	(Small-1)	(Small-2)	
(1 pc.)	(2 pcs.)	(1 pc.)	(2 pcs.)	(1 pc.)	
Screw	Conduit mounting plate		Others		
(1 pc.)	(2 pcs.)	(2 pcs.)	• Installation manual		

2-5 Main components

For main components and function of the main components, refer to the Engineering Data Book.

3. BEFORE INSTALLATION

(Bringing-in)

Bring in the outdoor unit slowly by holding the lugs provided on the left and right sides as shown in the figures below.

(Take care so that hands and objects do not touch the fin on the rear.)

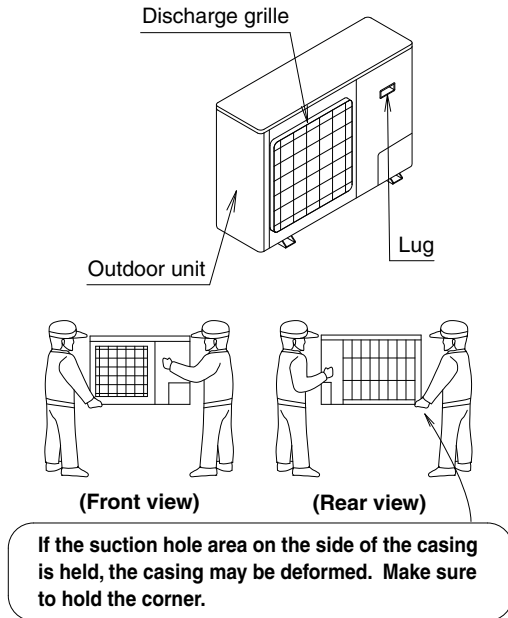

© Make sure to use accessories and specified specification parts in the installation work.

4. SELECTION OF INSTALLATION LOCATION

The refrigerant R410A itself is nontoxic, nonflammable and safe. If the refrigerant should leak however, its concentration may exceed the allowable limit depending on room size. Due to this it could be necessary to take measures against leakage. Refer to the chapter "Caution for refrigerant leaks".

- (1) **Select a proper location satisfying the following requirements with approval of the customer.**
 - Sufficient ventilation is secured.
 - Adjacent houses are not annoyed.
 - The foundation is strong enough to support the weight and withstand vibrations of the outdoor unit, and the location is safe and allows horizontal installation.
 - The outdoor unit is exposed to rain as less as possible.
 - The space for installation and servicing is secured around the outdoor unit.
 - The indoor/outdoor piping length and wiring length are within the allowable range.
- (2) **When installing the outdoor unit in a location affected by strong wind, pay special attention to the following items.**

- If strong wind whose velocity is 11 mph or more blows to the outdoor unit from the air outlet side, the air flow rate of the outdoor unit is reduced, the outlet air is sucked again (short-circuit), and the following effect may be caused:
 - The capacity is deteriorated.
 - The adhered frost increases during heating operation.
 - The operation is stopped by pressure rise.
- If excessive strong wind continuously blows from the air outlet side of the outdoor unit, the fan may rotate in the reverse direction at high speed, and lead to damage. Install the outdoor unit in reference to the following figures.

- **Position the air outlet side toward the building wall, fence or windbreak screen.**

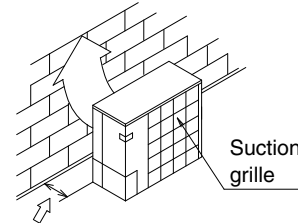

(Secure the space for installation and servicing.)

- **Let the air outlet direction face be at right angles to the wind direction.**

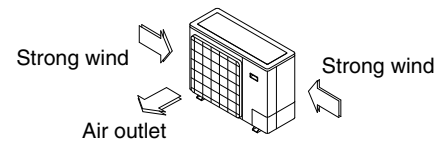

- (3) **When installing the outdoor unit in a location with heavy snowfall, pay special attention to the following items:**
 - Prepare strong foundation.
 - Attach the snow hood (optional accessory).
 - Remove the suction grill on the rear so that snow will not be accumulated in the rear fin.
- (4) **When there is a possibility of short-circuit depending on the ambient situation, use the wind direction adjusting plate (optional accessory).**
- (5) **The inverter type air conditioner may cause noise in electric products.**

When selecting an installation location, keep sufficient distance from the air conditioner units and wiring to radios, personal computers, stereos, etc. as shown in the figure below.

In areas with weak electric waves, keep a distance of 120 in. or more from the indoor remote controller, etc., put the power cables and connection cables in conduit tubes, and ground the conduit tubes.

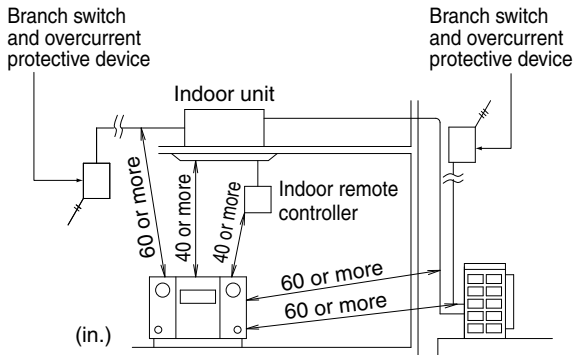

⚠ DANGER

- Do not install unit in an area where flammable materials are present due to risk of explosion resulting in serious injury or death.
- Refrigerant is heavier than air and replaces oxygen. A massive leak could lead to oxygen depletion, especially in basements, and an asphyxiation hazard could occur leading to serious injury or death.

Installation place (unit: inch)

⟨Cautions on continuous installation⟩

- The connection piping outlet direction in the continuous installation shown in the figures below is frontward or downward.
- When routing the piping rearward, secure space of 10 in. or more on the right side of the outdoor unit. (The unit of numeric values below is "inch".)
- Make some space for wiring with conduit and servicing between the units.

(A) When an obstruction is present on the air inlet side

• When the upward area is open

(1) When one outdoor unit is installed individually

- When an obstruction is present only on the air inlet side

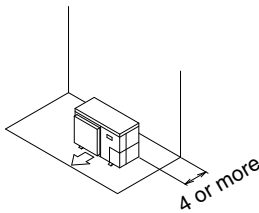

- When an obstruction is present on the both sides

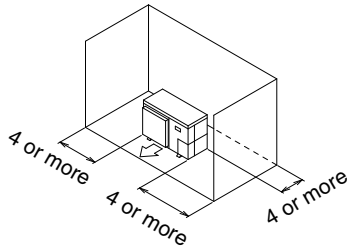

(2) When two or more outdoor units are installed side by side

- When an obstruction is present on the both sides

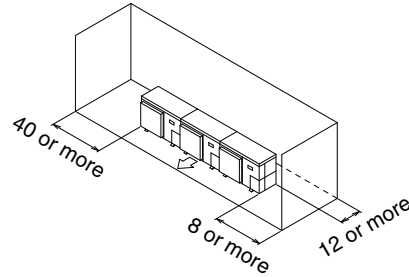

• When an obstruction is present also in the upward area

(1) When one outdoor unit is installed individually

- When an obstruction is present also on the air inlet side

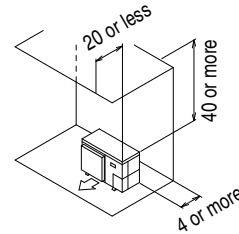

- When an obstruction is present also on the air inlet side and both sides

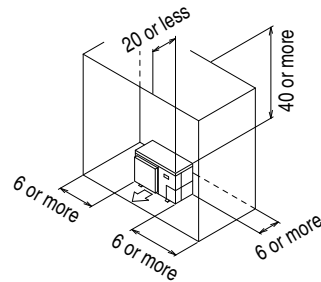

(2) When two or more outdoor units are installed side by side

- When an obstruction is present also on the air inlet side and both sides

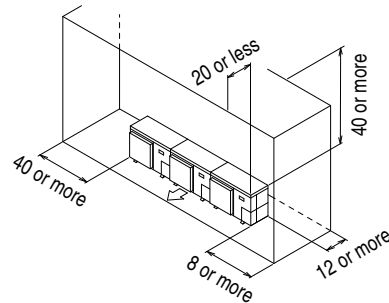

(B) When an obstruction is present on the air outlet side

- When the upward area is open
 - (1) When one outdoor unit is installed individually

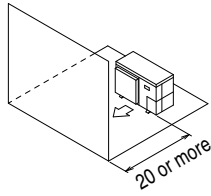

- (2) When two or more outdoor units are installed side by side

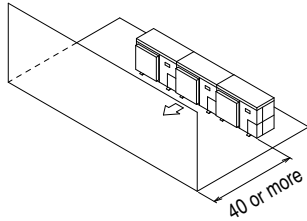

- When an obstruction is present also in the upward area

- (1) When one outdoor unit is installed individually

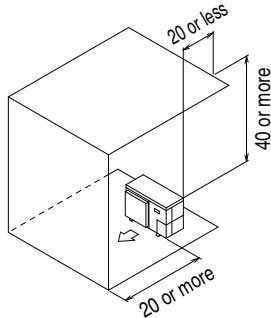

- (2) When two or more outdoor units are installed side by side

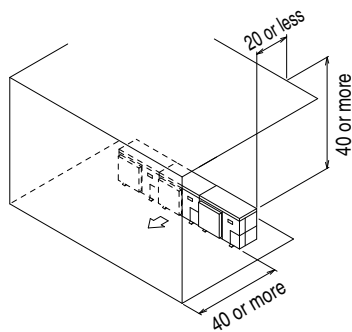

(C) When an obstruction is present on both the air inlet and air outlet sides

<Pattern 1>

When an obstruction on the air outlet side is higher than the outdoor unit (There is no restriction in the height of obstruction on the air inlet side.)

- When the upward area is open

- (1) When one outdoor unit is installed individually

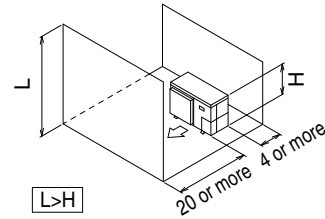

- (2) When two or more outdoor units are installed side by side

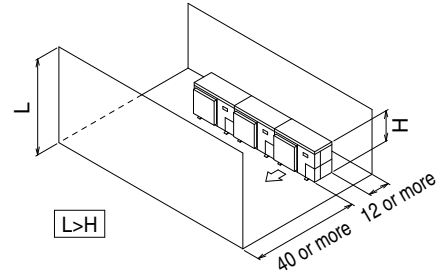

- When an obstruction is present also in the upward area

- (1) When one outdoor unit is installed individually

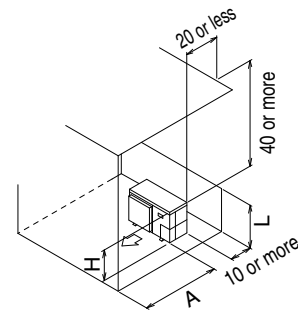

The dimensional relationship between H, L and A is as shown in the table below.

	L	A
$L \leq H$	$0 < L \leq 1/2H$	30
	$1/2H < L \leq H$	40
$H < L$	Install the frame to achieve "L ≤ H".	

NOTE

- Close the area under the frame so that the outlet air does not bypass there.

(2) When only two outdoor units are installed side by side

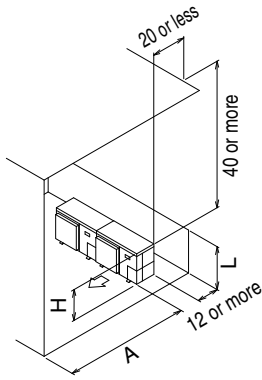

The dimensional relationship between H, L and A is as shown in the table below.

	L	A
L ≤ H	0 < L ≤ 1/2H	40
	1/2H < L ≤ H	50
H < L	Install the frame to achieve "L ≤ H".	

NOTE

1. Close the area under the frame so that the outlet air does not bypass there.
2. Only two outdoor units can be installed side by side.

<Pattern 2>

When an obstruction on the air outlet side is lower than the outdoor unit (There is no restriction in the height of obstruction on the air inlet side.)

• When the upward area is open

(1) When one outdoor unit is installed individually

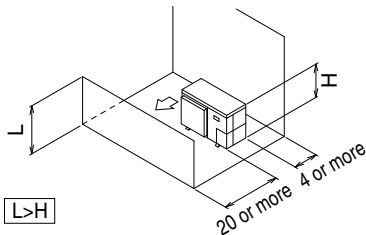

(2) When two or more outdoor units are installed side by side

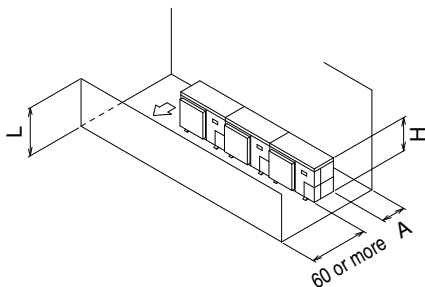

The dimensional relationship between H, L and A is as shown in the table below.

L	A
0 < L ≤ 1/2H	10
1/2H < L ≤ H	12

• When an obstruction is present also in the upward area
(1) When one outdoor unit is installed individually

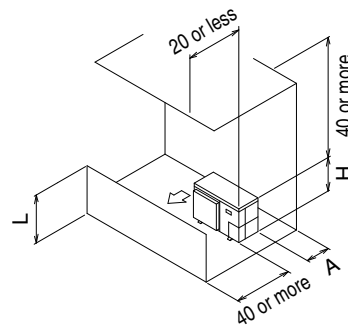

The dimensional relationship between H, L and A is as shown in the table below.

	L	A
L ≤ H	0 < L ≤ 1/2H	4
	1/2H < L ≤ H	8
H < L	Install the frame to achieve "L ≤ H".	

NOTE

- Close the area under the frame so that the outlet air does not bypass there.

(2) When only two outdoor units are installed side by side

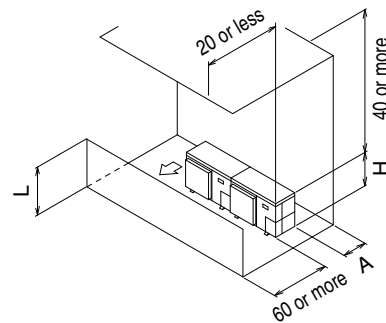

The dimensional relationship between H, L and A is as shown in the table below.

	L	A
L ≤ H	0 < L ≤ 1/2H	10
	1/2H < L ≤ H	12
H < L	Install the frame to achieve "L ≤ H".	

NOTE

1. Close the area under the frame so that the outlet air does not bypass there.
2. Only two outdoor units can be installed side by side.

(D) When outdoor units are stacked

(1) When an obstruction is present on the air outlet side

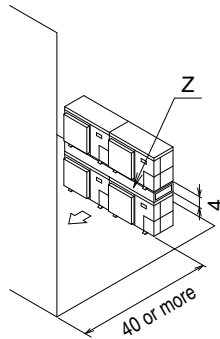

NOTE

1. Only two outdoor units can be stacked.
2. About 4 in. is required as the drain piping size for the upper outdoor unit.
3. Close the area Z (gap between the upper outdoor unit and the lower outdoor unit) so that the outlet air does not bypass there.

(2) When an obstruction is present on the air inlet side

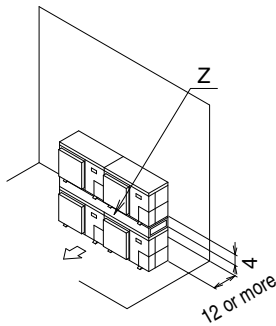

NOTE

1. Only two outdoor units can be stacked.
2. About 4 in. is required as the drain piping size for the upper outdoor unit.
3. Close the area Z (gap between the upper outdoor unit and the lower outdoor unit) so that the outlet air does not bypass there.

(E) When outdoor units are installed in rows (on the rooftop, etc.)

(1) When one outdoor unit is installed in each row

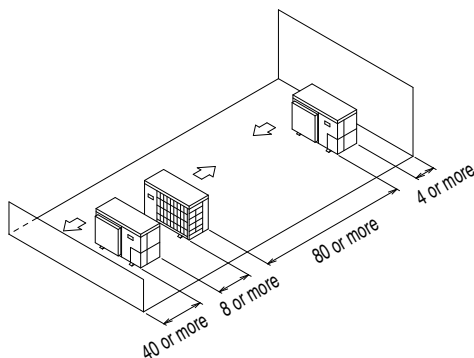

(2) When two or more outdoor units are installed side by side

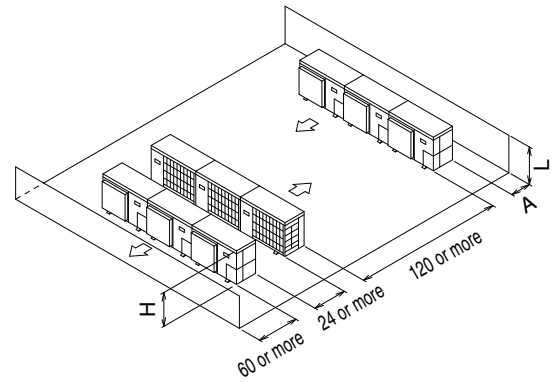

The dimensional relationship between H, L and A is as shown in the table below.

	L	A
L ≤ H	0 < L ≤ 1/2H	10
	1/2H < L ≤ H	12
H < L	Installation is not allowed.	

5. CAUTIONS ON INSTALLATION

- Before installation, confirm the strength and levelness of the foundation so that vibrations and noise are not generated.
- Fix the outdoor unit securely on a rigid base with foundation bolts as shown in the foundation drawing below. (Prepare 4 sets of commercially available M12-type or equivalent foundation bolts, nuts and washers.)
- Use resin washers to prevent the paint from being scratched off and rusting.
- The foundation bolts should be protruded by 15/16 in. (Refer to figure)

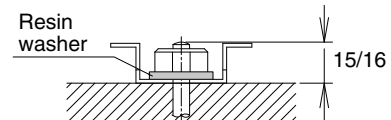

《Drain treatment》

- In a location where drain from the outdoor unit may cause troubles (for example, where drainage may splash on general passersby), perform the drain piping work using the drain plug (optional).
- For drain treatment, space of at least 4 in. is required under the bottom frame of the outdoor unit.
- In the drain piping work, make sure that drainage is discharged securely. (When routing the piping downward, check for water leakage.)

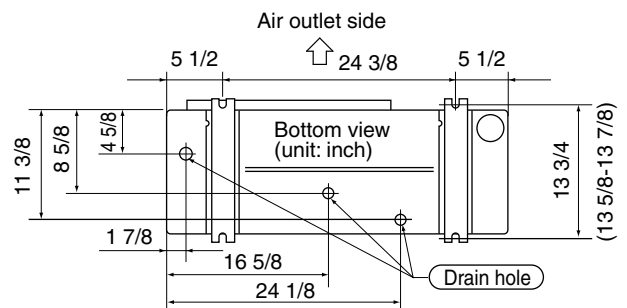

6. REFRIGERANT PIPING WORK

⚠ CAUTION

<To piping technician>

- **Make sure to open the stop valves after finishing the piping work. (Refer to the table shown in “6-7 Additional refrigerant charge”.)**

(Operating the air conditioner with the stop valve shut may damage the compressor.)

- Use R410A to add refrigerant. (The R410A refrigerant cylinder has a pink stripe painted around it.)
All field piping must be installed by a licensed refrigeration technician and must comply with relevant local and national regulations.

• BRAZING REFRIGERANT PIPING

Do not use flux when brazing copper-to-copper refrigerant piping. (Particularly for the HFC refrigerant piping) Therefore, use the phosphor copper brazing filler metal (BCuP) which does not require flux.

(Flux has an extremely negative effect on refrigerant piping systems. For instance, if chlorine based flux is used, it will cause pipe corrosion. Flux containing fluorine will damage refrigeration oil.)

⚠ NOTE

- Maximum piping length between the outdoor and indoor unit:

Indoor unit	FAQ	FTQ
	FCQ FHQ	
Max. piping length	164 ft.	98 ft.

• Installation tools:

Make sure to use installation tools (gauge manifold charge hose, etc.) that are exclusively used for R410A installations to withstand the pressure and to prevent foreign materials (e.g. mineral oils such as SUNISO and moisture) from mixing into the system.

(The screw specifications differ for R410A and R407C.)

Vacuum pump (use a 2-stage vacuum pump with a non-return valve):

1. Make sure the pump oil does not flow oppositely into the system while the pump is not working.
2. Use a vacuum pump which can evacuate to -14.6 psi.

6-1 Selection of piping material

1. Foreign materials inside pipes (including oils for fabrication) must be 0.14gr/10ft. or less.
2. Use the following material specification for refrigerant piping:
 - Construction material: Phosphoric acid deoxidized seamless copper for refrigerant.
 - Size: liquid pipe: $\phi 3/8"$
gas pipe: $\phi 5/8"$

6-2 Protection of piping

- Protect the piping to prevent moisture and dusts from coming into the piping.
- Especially, pay attention when passing the piping through a hole or connecting the end of piping to the outdoor.

Location	Working period	Protection method
Outdoor	1 month or more	Pinch pipes
	Less than 1 month	Pinch or tape pipes
Indoor	Regardless of period	

6-3 Piping connection

- For handling of stop valves, refer to “Stop valve operation method” in “6-7 Additional refrigerant charge”.
- **Only use the flare nuts attached to the stop valves. Using different flare nuts may cause the refrigerant to leak.**
- **Be sure to perform a nitrogen blow when brazing.**

(Brazing without performing nitrogen replacement or releasing nitrogen into the piping will create large quantities of oxidized film inside the pipes, adversely affecting valves and compressor in the refrigerating system and preventing normal operation.)

⚠ DANGER

- Use of oxygen could cause an explosion resulting in severe injury or death. Only use nitrogen gas.
- Refrigerant gas may produce toxic gas if it comes in contact with fire such as from a fan heater, stove or cooking device. Exposure to this gas could cause severe injury or death.

⚠ NOTE

- When brazing with blowing nitrogen, set the nitrogen pressure to 2.9 psi or less by using a pressure reducing valve.

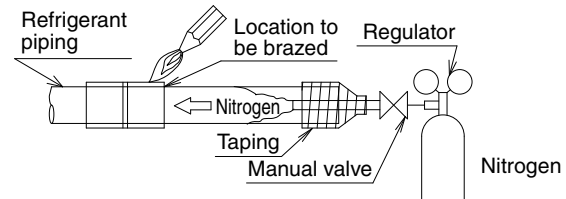

⚠ CAUTION

- Do not use anti-oxidants when brazing. Residue can clog pipes and break the unit.
- ⊙ Do not let any refrigerant other than the specified refrigerant enter the refrigerant system.
- ⊙ Do not let any gas such as air enter the refrigerant system.

<Precautions when connecting the piping>

- See the following table for flare dimensions.
- When connecting the flare nuts, apply refrigeration oil to the inside of the flares and turn them three or four times at first. (Use ester oil or ether oil.)
- See the following table for tightening torque. (Applying too much torque may cause the flares to crack.)
- After connecting all the piping perform a gas leak check by using nitrogen.

Pipe size	Tightening torque (ft-lbf)	Flare dimension A (in.)	Flare shape (in.)
φ3/8"	24.1 - 29.4	0.504 - 0.520	
φ5/8"	45.6 - 55.6	0.760 - 0.776	

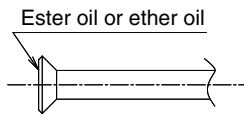

- If you are obliged to install the unit without a torque wrench, you may follow the installation method mentioned below. After the work is finished, make sure to check that there is no gas leak.
- When you keep on tightening the flare nut with a spanner, there is a point where the tightening torque suddenly increases. From that position, further tighten the flare nut the angle shown below.

Pipe size	Tightening angle (Guideline)	Recommended arm length of tool (in.)
φ3/8"	60°~90°	Approx. 7 7/8
φ5/8"	30°~60°	Approx. 11 13/16

Disposal requirements

Dismantling of the unit, treatment of the refrigerant, oil and eventual other parts should be comply the relevant local and national regulations.

6-4 Refrigerant piping work procedure

- ⊙ The field piping can be connected in three directions.

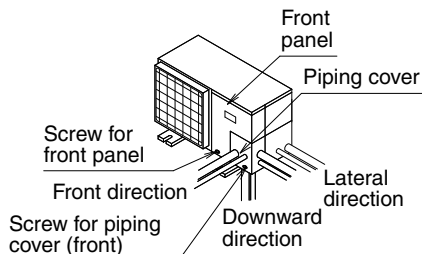

- ⊙ When connecting the piping downward, remove the knockout hole by making four holes in the middle on the each side of the knockout hole with a drill.

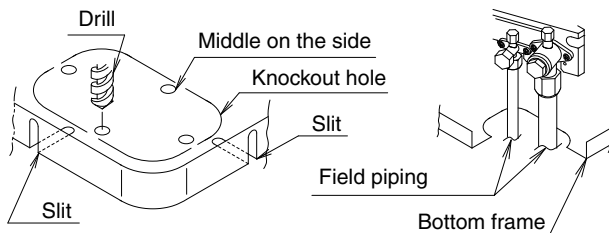

Then cut out the corner of the bottom frame along the slits (in two positions) by using a hacksaw.

- ⊙ After removing the parts, it is recommended to apply repair paint on the edges, to prevent rusting.

Cautions on connecting the connection piping

- When it is expected that water condensed in the stop valve will reach the indoor unit through the gap between the heat insulating material and the piping (for example, when the outdoor unit is installed in a higher position than the indoor unit), take proper action such as caulking the connection area.

[Measures to prevent invasion of small creatures and litter]

- Block all gaps in the piping penetration areas with putty or heat insulating material (arranged in the local field) as shown in the figure below.
(If small creatures such as insects or litter enter the outdoor unit, a short-circuit may be caused inside the control box.)

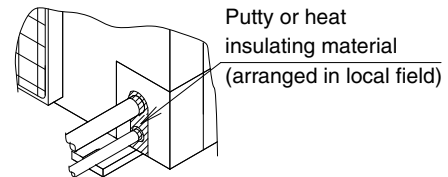

6-5 Heat insulation of piping

- Make sure to insulate the field piping (on both the liquid line and gas line) and refrigerant branching kit.
(If they are not insulated, water leakage may be caused.)

(The maximum temperature of the piping on the gas line is about 248 °F during heating operation. Use an insulation sufficiently resistant to this temperature.)

- Reinforce the refrigerant piping according to the installation environment. If it is not reinforced, condensate may form on the surface of the insulation.

⚠ WARNING

- Make sure to insulate the field piping up to the piping connection area inside the unit. If the piping is exposed, dew condensation and burn by contact may be caused.

6-6 Airtight test and vacuum drying

The unit has been checked for leaks by the manufacturer. Confirm that the valves are firmly closed before airtight test or vacuum drying.

To prevent entry of any impurities and insure sufficient pressure resistance, always use the special tools dedicated for R410A.

Perform the following inspections securely after the piping work.

- **Airtight test** - Make sure to use nitrogen gas. (For the service port position, refer to the figure in "Stop valve operation method".)

[Procedure] Pressurize the air conditioner from the liquid pipe and gas pipe up to 450 psi (Make sure not to exceed 450 psi). When the pressure does not drop for 24 hours, the piping work shall be accepted.

If the pressure drops, check for leakage positions. (Confirm that there is no leakage, then release nitrogen.)

- **Vacuum drying** - Use a vacuum pump which can evacuate up to -14.6 psi or less.
[Procedure] Operate the vacuum pump for evacuation for 2 hours or more using both liquid pipe and gas pipe until the vacuum pressure reaches -14.6 psi or less. Leave the air conditioner at -14.6 psi or less for 1 hour or more, and confirm that the vacuum pressure indicated by the vacuum gage does not increase.
(If the vacuum pressure increases, the system may contain moisture or have leakage.)

If there is a possibility of moisture remaining in the piping (for example, when there is a possibility of dew condensation inside the piping because the piping work was performed in the rainy season or over a long period of time, or when rainwater may have entered the piping during the work) Perform evacuation described above for 2 hours (vacuum drying), pressurize the air conditioner up to 7 psi (vacuum break) with nitrogen gas, then evacuate the air conditioner using the vacuum pump for 1 hour to achieve -14.6 psi or less (vacuum drying).
(If the vacuum pressure does not reach -14.6 psi or less even after evacuation for 2 hours or more, repeat vacuum break and vacuum drying.) Leave the air conditioner in the vacuum status for 1 hour or more, and confirm that the vacuum pressure indicated by the vacuum gauge does not increase.

6-7 Additional refrigerant charge

⚠ WARNING

- To avoid injury always use protective gloves and eye protection when charging refrigerant.
- To avoid injury do not charge with unsuitable substances. Use only the appropriate refrigerant.

⚠ NOTE

- Refrigerant cannot be charged until field wiring has been completed.
Refrigerant may only be charged after performing the airtight test and the vacuum drying (see above).
When charging refrigerant into the system, take care that its maximum allowable charge is never exceeded, in view of the danger of liquid hammer.
Refrigerant containers shall be opened slowly.
To avoid compressor breakdown, do not charge the refrigerant more than the specified amount to raise the condensing pressure.

- This outdoor unit is factory charged with refrigerant.
- Charge the additional refrigerant calculated by the formula below.

Additional charging amount (lb.)	=	Liquid piping length × 0.036 (ft.)×0.036	+	Additional charging depended on type of indoor unit A (lb.)
-------------------------------------	---	--	---	--

Indoor unit	FAQ FCQ FHQ	FTQ
Additional charging A (lb.)	0	1.54

Record the additional amount to the label stuck on the back of front panel.

- Charge the refrigerant to the liquid pipe in its liquid state. Since R410A is a mixed refrigerant, its composition changes if charged in a state of gas and normal system operation would no longer be assured.
- Before filling, check whether the tank has a siphon attached or not.

How to fill a tank with a siphon attached.

Fill with the tank upright.

(There is a siphon tube inside, so there is no need to turn the tank upside-down.)



Other ways of filling the tank

Fill with the tank upside-down.



- After the vacuum drying is finished, charge the additional refrigerant in its liquid state through the liquid stop valve service port.
Taking into account following instructions:
 1. Check that gas and liquid stop valves are closed.
 2. Charge the specified amount of refrigerant.
- If the outdoor unit is not in operation and the total amount cannot be charged, follow the procedures for additional refrigerant charge shown below.
- Make sure to use installation tools you exclusively use on R410A installations to withstand the pressure and to prevent foreign materials from mixing into the system.
- Procedures for charging additional refrigerant.

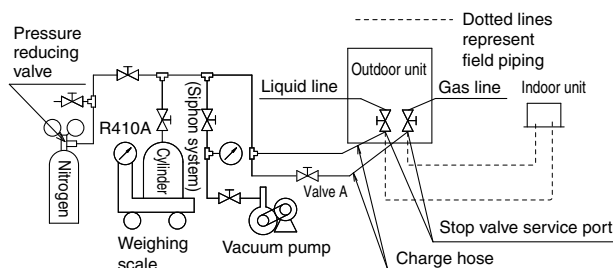

See the "Cautions on service" label on the back of the front panel for the settings for operation after replenishing refrigerant.

1. Open the gas line stop valve (leaving the liquid line stop valve, valve A in the diagram above, close) and perform the operation to add the refrigerant.
2. Once the appropriate amount of refrigerant is in, press the confirmation button (BS3) on the outdoor unit PC board (A2P), and stop operation.
3. Open the stop valves quickly (both liquid and gas line valves).
(This must be done quickly to avoid the possibility that the pipe might burst.)

Stop valve operation

Cautions on handling the stop valve

- The figure below shows the name of each part required in handling the stop valve. At the time of shipment, the stop valve is closed.

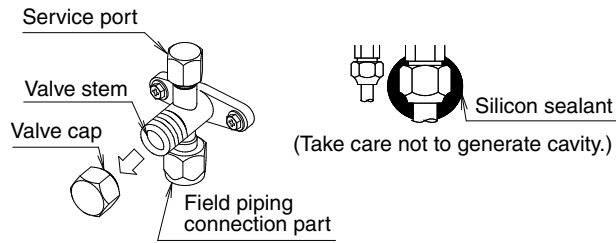

- If only a torque wrench is used to loosen or tighten the flare nut, the side plate may be distorted. Make sure to fix the stop valve with a spanner, then loosen or tighten the flare nut with a torque wrench.

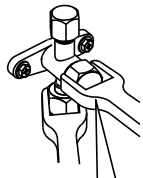

Spanner prohibition to valve cap and body part

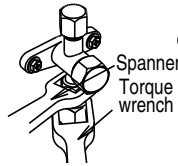

Stop valve of two hangs structure

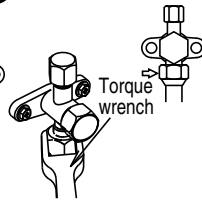

Stop valve of one hang structure

- When it is expected that the operating pressure will be low (for example, when cooling will be performed while the outside air temperature is low), seal sufficiently the flare nut in the stop valve on the gas line with silicon sealant to prevent freezing.

Cautions on handling the valve cap

- The valve is sealed in the arrow area. Take care not to damage the arrow area.

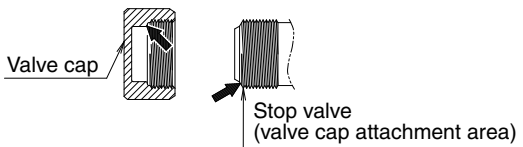

- After handling the valve, make sure to tighten the valve cap securely.

Liquid line	Gas line
10.0~12.2 ft-lbf	16.6~20.3 ft-lbf

Cautions on handling the service port

- Use charge hose equipped with push in the work.
- After the work, make sure to tighten the valve cap securely. Tightening torque.....8.5~10.3 ft-lbf

[Stop valve operation method]

Prepare hexagon wrenches (whose size is 4 mm and 6 mm).

How to open the stop valve

- Insert a hexagon wrench into the valve stem, and turn the valve stem counterclockwise.
- When the valve stem cannot be turned any more, stop turning. Now, the valve is open.

How to close the stop valve

- Insert a hexagon wrench into the valve stem, and turn the valve stem clockwise.
- When the valve stem cannot be turned any more, stop turning. Now, the valve is closed.

Opening direction



<Liquid line>

Opening direction

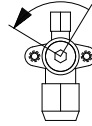

<Gas line>

7. ELECTRIC WIRING WORK

⚠ DANGER

- Do not ground units to water pipes, telephone wires or lightning rods because incomplete grounding could cause a severe shock hazard resulting in severe injury or death, and to gas pipes because a gas leak could result in an explosion which could lead to severe injury or death.

⚠ WARNING

- Disconnect all power to unit to avoid possible electric shock during installation.
- Use only specified wire and connect wires to terminals tightly. Be careful that wires do not place external stress on terminals. Keep wires in neat order so as to not to obstruct other equipment. Incomplete connections could result in overheating, and in worse cases, electric shock or fire. For the details, refer to "7-3 Power supply wiring connection procedure".

⚠ CAUTION

<To electrician>

- Do not operate the air conditioner until the refrigerant piping work is completed. (Operating the air conditioner before the refrigerant piping work is completed may damage the compressor.)
- Install a ground fault circuit interrupter. (The inverter is provided in the air conditioner. In order to prevent malfunction of the ground fault circuit interrupter itself, use a breaker resistant to higher harmonics.)

- Electricians having sufficient knowledge should perform the electric wiring work. All wiring must comply with local electrical codes and National Electrical Code (NEC).

- Perform the electric wiring work in accordance with the “electric wiring diagram label”.
Make sure to turn OFF the branch switch and overcurrent protective device before starting the work.
- Perform grounding to the indoor unit and outdoor unit.
- Use only copper wires.
- Make sure to turn the power off before starting the electric wiring work.
Do not turn ON any switch until the work is completed.
- The outdoor unit has an inverter which generates noise and charges the outer casing with the leakage current. The outdoor unit should be grounded so that the effect of the generated noise on other equipment can be reduced, and that the outer casing can be discharged.
- As this unit is equipped with an inverter, installing a phase advancing capacitor will not only reduce the power factor improvement factor, but may also cause the capacitor to overheat due to high-frequency waves. Therefore, never install a phase advancing capacitor.
- Never push excessive electric wires into the units.
- Protect electric wires with conduit tubes or vinyl tubes so that they will not be damaged by edges of knockout holes.
- Fix electric wires with clamps as accessories so that they will not come to contact with pipes and stop valves.
(Refer to “7-3 Power supply wiring connection procedure”.)

7-1 Connection example of whole system wiring

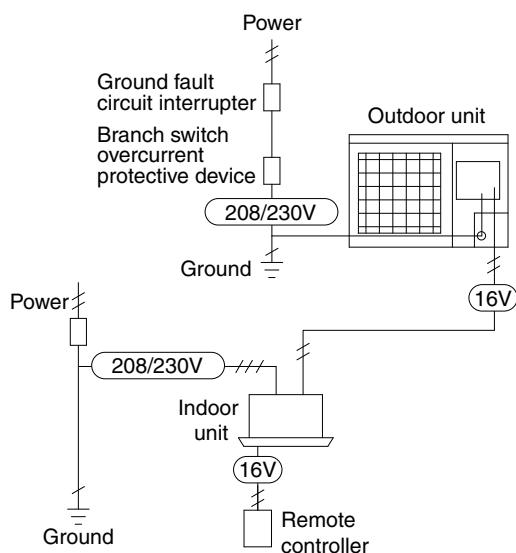

7-2 Routing power supply wiring and transmission wiring

Let the power supply wiring with a conduit pass through one of the knockout holes on the front or side cover, and let the transmission wiring with a conduit pass through another knockout hole.

- For protection from uninsulated live parts, thread the power supply wiring or the transmission wiring through the included insulating tube and secure it with the included clamp.

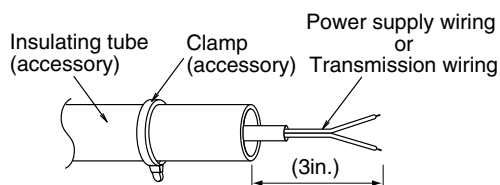

⚠️ Precautions when knocking out knockout holes

- To punch the knockout hole, hit it with a hammer.
- After removing the knockout hole, it is recommended that the edges should be painted to prevent rusting.

⚠️ CAUTION

- Use conduit for both the power supply wiring and transmission wiring.
- Outside the unit, make sure to keep the wirings 5 inches away.
Otherwise, the outdoor unit may be affected by electrical noise (external noise), and malfunction or fail.
- Be sure to connect the power supply wiring to the terminal block and secure it as described in “7-3 Power supply wiring connection procedure”.
- Fix the wiring between the units in accordance with “7-4 Transmission wiring connection procedure”.
- Secure the wirings with the clamps (accessory) so that do not touch the piping.
- Make sure the wirings will not be pinched by the front panel, and close the panel firmly.
- Route the conduit along the unit by using an elbow socket and so on to prevent it from being stepped on.

7-3 Power supply wiring connection procedure

⚠️ WARNING

- Never connect power supply wiring to the terminal block for remote controller wiring as this could damage the entire system.

Install a ground fault circuit interrupter.

- It is obliged to install a ground fault circuit interrupter to prevent electric shock and fire accident.

Model	Phase and frequency	Voltage	Max. Overcurrent Protective Device	Min. Circuit Amps.
RZQ18PVJU RZR18PVJU	~ 60Hz	208/230V	20A	16.5A
RZQ24PVJU RZR24PVJU				
RZQ30PVJU RZR30PVJU				

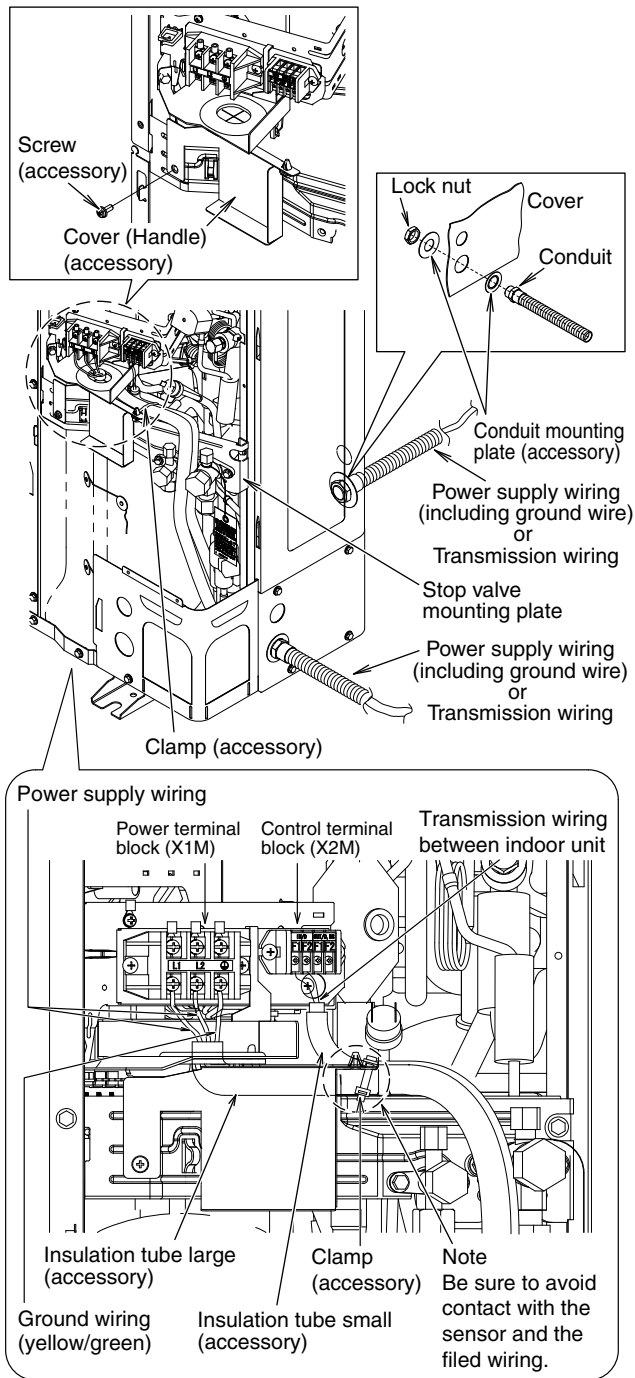

How to Insulation tube.

- Use the insulation tube large to cover the power supply wiring.
Use the insulation tube small to cover the transmission wiring.
- Joint the insulation tube with the tape and cut off the tube sticking out of the outdoor unit.

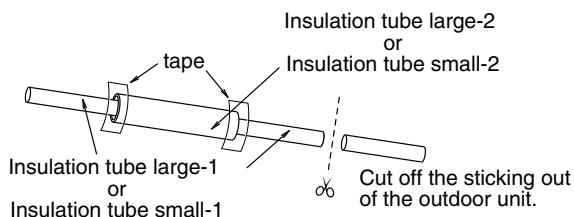

CAUTION

- After finishing the electric wiring work, confirm that all the wirings are connected securely.

«Precautions when laying power wiring»

- Two electric wires of different thickness cannot be connected to the power terminal block.
(Slack in the electric wires may generate abnormal heat.)
- Use round pressure terminals with insulating sleeve for connection to the power terminal block.
If such terminals are not available for unavoidable reasons, connect an electric wire of the same thickness to each side as shown in the figure.

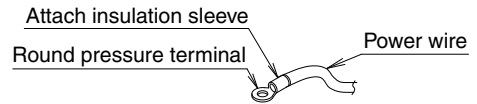

Connect same-thickness wiring to both sides.



It is forbidden to connect two to one side.



It is forbidden to connect wiring of different thicknesses.



Make sure to observe the following items. If they are not observed, abnormal heat may be generated by slack in electric wires, etc.

- For wiring, use the designated power wire and connect firmly, then secure to prevent outside pressure being exerted on the terminal board.
- Use an appropriate screwdriver for tightening the terminal screws.
A screwdriver with a small head will strip the head and make proper tightening impossible.
- Over-tightening the terminal screws may break them.
- See the table below for tightening torque for the terminal screws.

Tightening torque (ft-lbf)		
M5	(Power supply and ground terminal block)	1.76 ~ 2.15
M4	(Shielded ground)	0.87 ~ 1.06
M3.5	(Transmission wiring terminal block)	0.58 ~ 0.72

7-4 Transmission wiring connection procedure

- If an excessive force is applied while connecting a cable to the terminal block on the PC board, the PC board may be damaged.

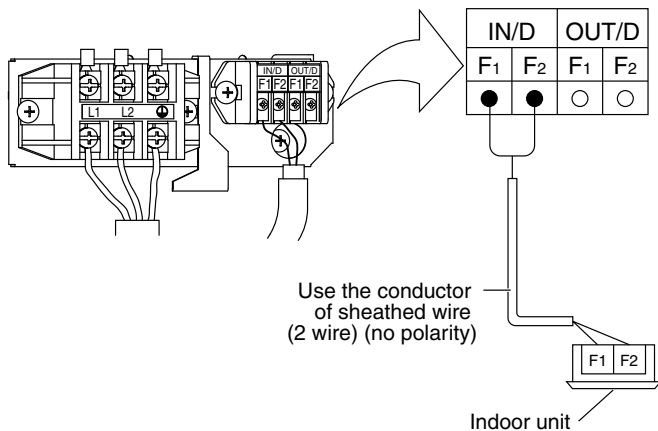

CAUTION

- For low-noise operation, it is necessary to install the optional "External control adaptor for outdoor unit". For details, see the installation manual attached to the adaptor.

Caution on the wiring length between units

Make sure to observe the restrictions below. If they are not observed, transmission error may occur.

Maximum wiring length: 3280 ft.

Cautions on the wiring between units

- Never connect 208/230V to the terminal block for the transmission wiring. Doing so will break the entire system.
- The transmission wiring from the indoor unit must be connected to the F1/F2 (TO IN/D UNIT) terminals on the PC board in the outdoor unit.
- * Make sure to use sheathed two-core cables of AWG18-16 in the wiring shown above.
- * **All cables used in the wiring between the units should be procured on the site.**

8. CHECKS AFTER COMPLETION OF WORK

After completing the work, make sure to confirm the following items:

1. Connection of drain piping and removal of transport fittings: Refer to "5. CAUTIONS ON INSTALLATION".
2. Connection of power supply wiring and tightening of screws: Refer to "7-3 Power supply wiring connection procedure".
3. Connection of transmission wiring and tightening of screws: Refer to "7-4 Transmission wiring connection procedure".
4. Freezing connection of refrigerant piping: Refer to "6. REFRIGERANT PIPING WORK".

5. Piping size and heat insulation: Refer to "6-1 Selection of piping material", "6-5 Heat insulation of piping".
6. Check of stop valve: Confirm that the stop valve is open on both the liquid line and gas line.
7. Record of amount of additional refrigerant: Record the amount on the label stuck on the back of the front panel.
8. Measurement of insulation in main power circuit:
 - Use the megatester for 500 V.
 - Do not use any megatester for low voltage electric circuits except 230 V. (Wiring between the outdoor unit and the indoor unit)

CAUTION

<To piping technician>

- Make sure to open the stop valve after finishing the piping work. (Operating the air conditioner with the stop valve shut may damage the compressor.)

9. TEST RUN PROCEDURE

A crankcase heater is mounted for smooth startup. Make sure to turn on the power 6 hours before starting operation for supplying the power to the crankcase heater.

WARNING

- Make sure to close the front panel before leaving the outdoor unit in the power ON status.
- To avoid injury, always make sure that the overcurrent protective device on the power supply panel of the installation is switched off before doing any work.

Cautions before turning on the power

- **Put the insulating cover securely onto the control box.**
- **After turning on the power, check the settings and LED indicators on the PC board (A1P) in the outdoor unit through the opening of the insulating cover.**

9-1 Power on and check operation

- Make sure to perform the check operation after installation. (If the air conditioner is operated using the indoor remote controller without performing the check operation, the malfunction code "U3" is displayed in the indoor remote controller, and normal operation is disabled.)

- In the check operation, the status of the outdoor unit is checked, and incorrect wiring is checked for.

<p>(1) • Close the front panel of the outdoor unit.</p> <ul style="list-style-type: none"> • Turn ON the power to the outdoor unit and indoor unit. 	<p>Caution</p> <p>Make sure to turn on the power 6 hours before starting operation for supplying the power to the crankcase heater.</p>																																																																																																									
<p>(2) • Open the front panel of the outdoor unit.</p> <ul style="list-style-type: none"> • Check the LED on the PC board (A1P and A2P) in the outdoor unit to see if the data transmission is performed normally. 	<p>The power is supplied to the outdoor unit. Take due care during the work to prevent electric shock.</p>																																																																																																									
<table border="1"> <tr> <td></td> <td>A1P</td> <td colspan="7">A2P</td> </tr> <tr> <td rowspan="4">LED display (Default status before delivery)</td> <td>SERVICE MONITOR</td> <td></td> <td></td> <td></td> <td></td> <td></td> <td></td> <td>DEMAND</td> </tr> <tr> <td>MODE</td> <td></td> <td></td> <td></td> <td></td> <td></td> <td></td> <td>L.N.O.P.</td> </tr> <tr> <td>TEST/HWL</td> <td></td> <td></td> <td></td> <td></td> <td></td> <td></td> <td>SLAVE</td> </tr> <tr> <td></td> <td></td> <td></td> <td></td> <td></td> <td></td> <td></td> <td>MASTER</td> </tr> <tr> <td></td> <td></td> <td>IND</td> <td></td> <td></td> <td></td> <td></td> <td></td> <td></td> </tr> <tr> <td></td> <td></td> <td></td> <td></td> <td></td> <td></td> <td></td> <td></td> <td></td> </tr> <tr> <td></td> <td></td> <td></td> <td></td> <td></td> <td></td> <td></td> <td></td> <td></td> </tr> <tr> <td></td> <td></td> <td></td> <td></td> <td></td> <td></td> <td></td> <td></td> <td></td> </tr> <tr> <td></td> <td></td> <td></td> <td></td> <td></td> <td></td> <td></td> <td></td> <td></td> </tr> <tr> <td></td> <td></td> <td></td> <td></td> <td></td> <td></td> <td></td> <td></td> <td></td> </tr> <tr> <td>Outdoor unit installed</td> <td>●</td> <td>●</td> <td>●</td> <td>○</td> <td>●</td> <td>●</td> <td>●</td> <td>●</td> </tr> </table> <p>LED display: ● OFF ○ ON ● Blinking</p>			A1P	A2P							LED display (Default status before delivery)	SERVICE MONITOR							DEMAND	MODE							L.N.O.P.	TEST/HWL							SLAVE								MASTER			IND																																																				Outdoor unit installed	●	●	●	○	●	●	●	●
	A1P	A2P																																																																																																								
LED display (Default status before delivery)	SERVICE MONITOR							DEMAND																																																																																																		
	MODE							L.N.O.P.																																																																																																		
	TEST/HWL							SLAVE																																																																																																		
								MASTER																																																																																																		
		IND																																																																																																								
Outdoor unit installed	●	●	●	○	●	●	●	●																																																																																																		
<p>(3) • When performing the low-noise operation (L.N.O.P.) or demand (DEMAND) operation upon request from the customer, perform the setting using the pushbutton switches (BS1 to BS5) on the PC board (A2P) in the outdoor unit.</p> <ul style="list-style-type: none"> • Press each pushbutton switch from the opening of the insulation cover. (Do not remove the insulation cover.) 	<ul style="list-style-type: none"> • The power is supplied to the outdoor unit. Take due care during the work to prevent electric shock. • Before using the pushbutton switches (BS1 to BS5) for setting, confirm that the microcomputer (SERVICE) monitor is lit. • For the setting method, refer to the [Cautions on service] label attached on the back of the front panel of the outdoor unit. (Make sure to write the contents of setting on the [Cautions on service] label.) 																																																																																																									
<p>(4) Confirm that the stop valves are open on both the liquid and gas lines. If they are closed, open them.</p>	<p>Caution</p> <p>Do not leave any stop valve closed. Otherwise the compressor will fail.</p>																																																																																																									
<p>(5) Press and hold the test run button (BS4) for 5 seconds or more to start the check operation. For the details, refer to the Check operation procedure on the [Cautions on service] label.</p>	<ul style="list-style-type: none"> • When leaving the outdoor unit during the check operation for unavoidable reasons, ask another installation worker to watch the outdoor unit, or close the front panel. • The system operates the check operation for about 15 minutes (30 minutes maximum), then stops automatically. The system can start normal operation about 5 minutes <u>after the check operation</u> if the remote controller does not display any malfunction code. • During the check operation, the status under execution is indicated on the remote controller. 																																																																																																									
<p>(6) After the check operation, make sure to close the front panel of the outdoor unit.</p>																																																																																																										

<Cautions on check operation>

- If the air conditioner is started within about 12 minutes after the power of the indoor/outdoor unit is turned on, the H2P indicator lights and the compressor does not run. Confirm that the LED status is as shown in the table in (2) in “9-1 Power on and check operation” before starting the air conditioner.
- The air conditioner may require about 10 minutes maximum until it can start the compressor after start of operation. This period of time is required to homogenize the refrigerant status, and does not indicate any failure.
- The check operation does not provide any means of checking the indoor unit individually. For that purpose, perform the normal operation using the remote controller after finishing the check operation.
- The check operation is not available in any other mode such as the recovery mode.
- Before running a check on the unit, changing the indoor remote controller settings might cause the error code “UF” to be displayed and prevent a proper check to be run.

9-2 Checks in normal operation

- After finishing the check operation, operate the air conditioner normally. (Heating is not available if the outside air temperature is 75 °F or more. Refer to the operation manual supplied together with the unit.) (Heating is only available for RZQ-P models.)
- Confirm that the indoor and outdoor units are operating normally. (If a knocking sound is heard in the liquid compression of the compressor, stop the air conditioner immediately and energize the crankcase heater for a sufficient period of time, then start the operation again.)
- Check to see if cold (or hot) air is coming out of the indoor unit.
- Press the fan direction button and fan speed control button on the remote controller to see if the fan is operating normally.

<Cautions for normal operation check>

- Once stopped, the compressor will not start for about 5 minutes even if the “ON/OFF” button on the remote controller is pressed.
- When the system operation is stopped by the remote control, the outdoor unit may continue to operate for a further 3 minutes.
- If the system has not undergone the check operation by the test run button since it was first installed, a malfunction code “U3” is displayed. In this case, perform the check operation by referring to “9-1 Power on and check operation”.

When a malfunction code is displayed in the remote controller

(Check a malfunction code in the remote controller connected to the indoor unit.)

Malfunction code	Cause	Solution
E3	The stop valves in the outdoor unit remain closed.	Open the stop valve on both the gas and liquid lines.
	The refrigerant is overcharged.	Calculate again the required amount of refrigerant to be charged based on the piping length, recover the refrigerant using the refrigerant recovery device, then achieve proper amount of refrigerant.
E4 F3	The stop valves in the outdoor unit remain closed.	Open the stop valve on both the gas side and liquid side.
	The operation mode on the remote controller was changed before the check operation.	Set the operation mode on all indoor unit remote controllers to "cooling."
	The refrigerant is insufficient.	<ul style="list-style-type: none"> • Check whether additional refrigerant charge has been finished correctly. • Calculate again the required amount of refrigerant to be charged based on the piping length, then charge additionally proper amount of refrigerant.
F6	The refrigerant is overcharged.	Calculate again the required amount of refrigerant to be charged based on the piping length, recover the refrigerant using the refrigerant recovery device, then achieve proper amount of refrigerant.
U3	The check operation has not performed.	Perform the check operation.
U4	The power is not supplied to the outdoor unit.	Connect correctly the power supply wiring of the outdoor unit.
UA	Improper type of indoor unit is connected.	Check the type of indoor unit currently connected. If it is not proper, replace it with proper one.
UF	The stop valves in the outdoor unit remain closed.	Open the stop valve on both the gas and liquid lines.
	The piping and wiring of the indoor unit are not connected correctly to the outdoor unit.	Confirm that the piping and wiring of the indoor unit are connected correctly to the outdoor unit.
	The operation mode on the remote controller was changed before the check operation.	Set the operation mode on indoor unit remote controller to "cooling."
UH	The transmission wiring is not connected correctly.	Connect correctly the transmission wiring to the F1 and F2 (TO IN/D UNIT) terminals on the PC board (A1P) in the outdoor unit.

When nothing is displayed in the remote controller

- There might be a problem with the connection or transmission between the indoor unit and the remote controller. Check connections, and check for wire breakage.

⚠ CAUTION

<To piping technician>

<To electrician>

- **After finishing the test run and before using the unit by customer, confirm that the front panel and screws are attached securely to the unit.**

10. CAUTION FOR REFRIGERANT LEAKS

⚠ DANGER

- Refrigerant gas is heavier than air and replaces oxygen. A massive leak could lead to oxygen depletion, especially in basements, and an asphyxiation hazard could occur leading to serious injury or death.

(Points to note in connection with refrigerant leaks)

Introduction

The installer and system specialist shall secure safety against leakage according to local regulations or standards. The following standards may be applicable if local regulations are not available.

The Split System, like other air conditioning systems, uses R410A as refrigerant. R410A itself is an entirely safe non-toxic, non-combustible refrigerant. Nevertheless care must be taken to ensure that air conditioning facilities are installed in a room which is sufficiently large. This assures that the maximum concentration level of refrigerant gas is not exceeded, in the unlikely event of major leak in the system and this in accordance to the local applicable regulations and standards.

Maximum concentration level

The maximum charge of refrigerant and the calculation of the maximum concentration of refrigerant is directly related to the humanly occupied space in to which it could leak.

The unit of measurement of the concentration is lb./ft³ (the weight in lb. of the refrigerant gas in 1ft³ volume of the occupied space).

Compliance to the local applicable regulations and standards for the maximum allowable concentration level is required.

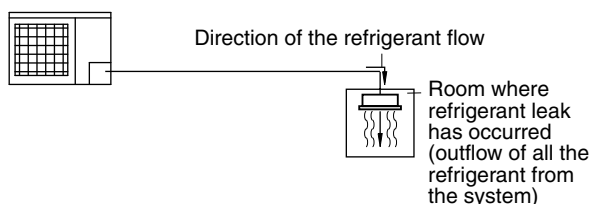

Pay a special attention to the place, such as a basement, etc. where refrigerant can stay, since refrigerant is heavier than air.

Procedure for checking maximum concentration

Check the maximum concentration level in accordance with steps 1 to 4 below and take whatever action is necessary to comply.

1. Calculate the amount of refrigerant (lb.) charged to each system separately.

amount of refrigerant in the unit (amount of refrigerant with which the system is charged before leaving the factory)	+	additional charging amount (amount of refrigerant added locally in accordance with the length or diameter of the refrigerant piping and type of indoor unit)	=	total amount of refrigerant (lb.) in the system
---	---	--	---	---

NOTE

- Where a single refrigerant facility is divided into 2 entirely independent refrigerant systems then use the amount of refrigerant with which each separate system is charged.

2. Calculate a room volume (ft³)

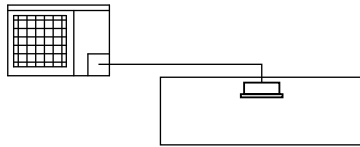

3. Calculate the refrigerant concentration by using the results of the calculations in steps 1 and 2 above.

total amount of refrigerant in the system	÷	volume (ft ³) of the room in which there is an indoor unit installed	≤	maximum concentration level (lb./ft ³)
---	---	--	---	--

4. Deal with the situations where the result exceeds the maximum concentration level.
Where the installation of a facility results in a concentration in excess of the maximum concentration level then it will be necessary to revise the system.
Please consult your dealer.

DAIKIN AC (AMERICAS), INC.

1645 Wallace Drive, Suite 110
Carrollton, TX 75006

info@daikinac.com
www.daikinac.com

DAIKIN INDUSTRIES, LTD.

Head office:

Umeda Center Bldg., 2-4-12, Nakazaki-Nishi,
Kita-ku, Osaka, 530-8323 Japan

Tokyo office:

JR Shinagawa East Bldg., 2-18-1, Konan,
Minato-ku, Tokyo, 108-0075 Japan

